

CE EN 1856-1:2009  
EN 14989-2:2007  
No. 0432-CPR-00095-320

TRIO

Sistema camino coassiale in tripla parete in acciaio inox, isolato.

La tubazione interna e la tubazione esterna formano due vie di flusso:

- nella via centrale vengono espulsi i fumi che si formano dalla combustione
- nella via più esterna, tramite il terminale, convoglia l'aria che viene aspirata dall'apparecchio termico
- la parte di coibentazione di spessore 30 mm presente tra le due vie di flusso permette di mantenere i fumi di scarico ad una temperatura ottimale anche in caso di apparecchi termici che dichiarino temperature di uscita fumi molto basse (sotto i 90°C)
- migliora il rendimento della stufa con un conseguente importante risparmio energetico

Concentric insulated triple wall system in stainless steel.

The inner pipe and the external pipe form two flow paths:

- combustion fumes are expelled by the inner pipe
- in the outer pipe, the combustible air is conveyed from the cap to the generator
- the 30 mm thick insulation part between internal and external pipes allows to keep the exhaust fumes at a good temperature even in case of heating appliances with very low outlet temperatures (below 90°C)
- it improves stove efficiency with consequent important energy savings

Système concentrique isolé en acier inox triple paroi.

Le tuyau interne et le tuyau externe forment deux voies d'écoulement :

- les fumées de combustion sont expulsées par le tuyau intérieur
- dans le tuyau extérieur, l'air combustible est amené du chapeau au générateur
- la partie isolante de 30 mm d'épaisseur entre les tuyaux interne et externe permet de maintenir les fumées d'échappement à une bonne température même en cas d'appareils de chauffage avec des températures de sortie très basses (inférieures à 90°C)
- il améliore la performance du poêle avec d'importantes économies d'énergie

T450-N1-W-V2-L50050-G50

Ø disponibili  
Ø available  
Ø disponibles

da 80 a 180 mm

Finiture disponibili  
Available finishes  
Finitions disponibles





### T250

Elemento lineare  
Linear element - Élément droit

Finiture disponibili - Available finishes - Finitions disponibles

F.08 - INOX SS - INOX	F.10 - NERO BLACK - NOIR	Øi	Øe	L	⊠
TK080T250	TNY080T250	80	200	250	1
TK100T250	TNY100T250	100	220	250	1
TK130T250	TNY130T250	130	250	250	1
TK150T250	TNY150T250	150	270	250	1
TK180T250	TNY180T250	180	300	250	1

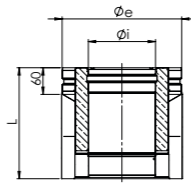

### T500

Elemento lineare  
Linear element - Élément droit

Finiture disponibili - Available finishes - Finitions disponibles

F.08 - INOX SS - INOX	F.10 - NERO BLACK - NOIR	Øi	Øe	L	⊠
TK080T500	TNY080T500	80	200	500	1
TK100T500	TNY100T500	100	220	500	1
TK130T500	TNY130T500	130	250	500	1
TK150T500	TNY150T500	150	270	500	1
TK180T500	TNY180T500	180	300	500	1

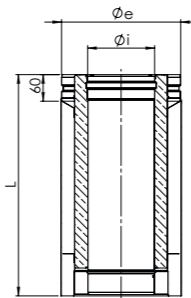

### T100

Elemento lineare  
Linear element - Élément droit

Finiture disponibili - Available finishes - Finitions disponibles

F.08 - INOX SS - INOX	F.10 - NERO BLACK - NOIR	Øi	Øe	L	⊠
TK080T100	TNY080T100	80	200	1000	1
TK100T100	TNY100T100	100	220	1000	1
TK130T100	TNY130T100	130	250	1000	1
TK150T100	TNY150T100	150	270	1000	1
TK180T100	TNY180T100	180	300	1000	1

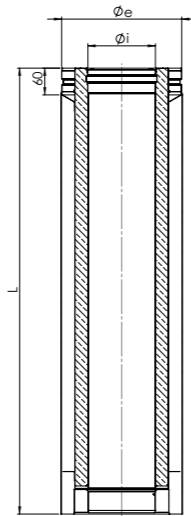

### TELE

Elemento telescopico  
Telescopic element - Élément télescopique

Finiture disponibili - Available finishes - Finitions disponibles

F.08 - INOX SS - INOX	F.10 - NERO BLACK - NOIR	Øi	Øe	⊠
TK080TELE	TNY080TELE	80	200	1
TK100TELE	TNY100TELE	100	220	1
TK130TELE	TNY130TELE	130	250	1
TK150TELE	TNY150TELE	150	270	1
TK180TELE	TNY180TELE	180	300	1

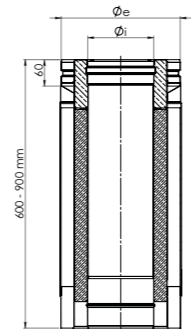

### C045

Curva 45°  
45° Bend - Coude 45°

Finiture disponibili - Available finishes - Finitions disponibles

F.08 - INOX SS - INOX	F.10 - NERO BLACK - NOIR	Øi	Øe	L	⊠
TK080C045	TNY080C045	80	200	141	1
TK100C045	TNY100C045	100	220	146	1
TK130C045	TNY130C045	130	250	152	1
TK150C045	TNY150C045	150	270	156	1
TK180C045	TNY180C045	180	300	162	1

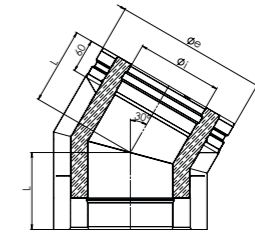

### C030

Curva a 30°  
30° Bend - Coude 30°

Finiture disponibili - Available finishes - Finitions disponibles

F.08 - INOX SS - INOX	F.10 - NERO BLACK - NOIR	Øi	Øe	L	⊠
TK080C030	TNY080C030	80	200	127	1
TK100C030	TNY100C030	100	220	130	1
TK130C030	TNY130C030	130	250	134	1
TK150C030	TNY150C030	150	270	136	1
TK180C030	TNY180C030	180	300	140	1

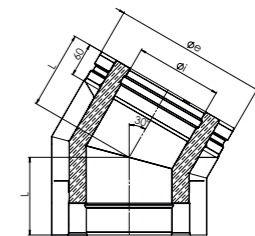

### T090

Raccordo a "T" 90° maschio-femmina  
90° Tee Pipe fitting male-female - Té 90° mâle-femelle

Finiture disponibili - Available finishes - Finitions disponibles

F.08 - INOX SS - INOX	F.10 - NERO BLACK - NOIR	Øi	Øe	L	L1	L2	⊠
TK080T090	TNY080T090	80	200	400	200	200	1
TK100T090	TNY100T090	100	220	420	210	210	1
TK130T090	TNY130T090	130	250	450	225	225	1
TK150T090	TNY150T090	150	270	470	235	235	1
TK180T090	TNY180T090	180	300	500	250	250	1

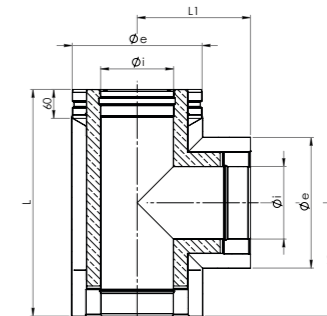

### T27A

Raccordo a 135° per ingresso aria  
135° Pipe fitting for air intake - Raccord à 135° pour entrée d'air

Finiture disponibili - Available finishes - Finitions disponibles

F.08 - INOX SS - INOX	F.10 - NERO BLACK - NOIR	Øi	Øe	L	⊠
TK080T27A	TNY080T27A	80	200	270	1
TK100T27A	TNY100T27A	100	220	270	1

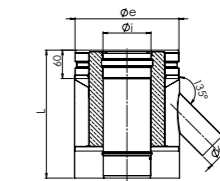



### RAC4

Raccordo a "T" 90° partenza da terra telescopico con ispezione  
Telescopic 90° tee pipe fitting from the ground with inspection  
Té 90° télescopique départ au sol avec trappe de visite

Finiture disponibili - Available finishes - Finitions disponibles

F.08 - INOX SS - INOX	F.10 - NERO BLACK - NOIR	Øi	Øe	L	L1	
TK080RAC4	TNY080RAC4	80	200	325-375	170-220	1
TK100RAC4	TNY100RAC4	100	220	345-395	180-230	1

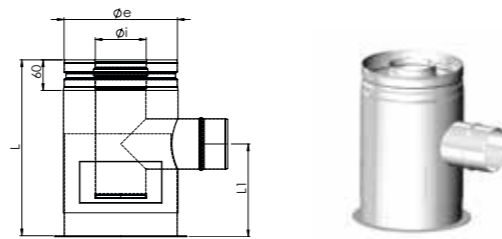

### RAC5

Raccordo a "T" 90° con ispezione laterale  
90° Tee pipe fitting with lateral inspection - Té 90° avec trappe de visite laterale

Finiture disponibili - Available finishes - Finitions disponibles

F.08 - INOX SS - INOX	F.10 - NERO BLACK - NOIR	Øi	Øe	L	L1	L2	
TK130RAC5	TNY130RAC5	130	250	550	195	345	1
TK150RAC5	TNY150RAC5	150	270	570	205	355	1
TK180RAC5	TNY180RAC5	180	300	600	220	370	1

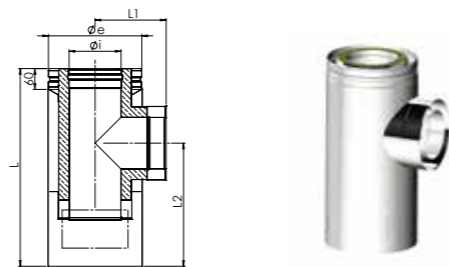

### T10A

Raccordo di partenza per ingresso aria  
Initial pipe fitting for air intake - Raccord initial pour entrée d'air

Finiture disponibili - Available finishes - Finitions disponibles

F.08 - INOX SS - INOX	F.10 - NERO BLACK - NOIR	Øi	Øe	L	
TK130T10A	TNY130T10A	130	250	1000	1
TK150T10A	TNY150T10A	150	270	1000	1
TK180T10A	TNY180T10A	180	300	1000	1

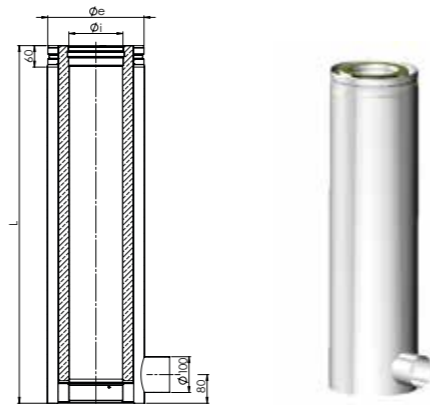

### T50A

Raccordo di partenza per ingresso aria  
Initial pipe fitting for air intake - Élément initial pour entrée d'air

Finiture disponibili - Available finishes - Finitions disponibles

F.08 - INOX SS - INOX	F.10 - NERO BLACK - NOIR	Øi	Øe	L	
TK130T50A	TNY130T50A	130	250	500	1
TK150T50A	TNY150T50A	150	270	500	1
TK180T50A	TNY180T50A	180	300	500	1

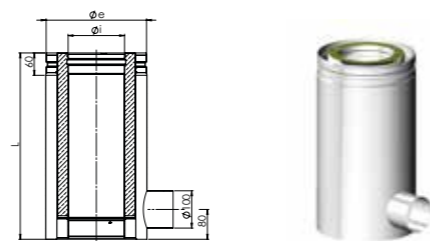

### T90A

Raccordo telescopico con presa d'aria  
Telescopic pipe fitting with air intake - Élément télescopique avec prise d'air

Finiture disponibili - Available finishes - Finitions disponibles

F.08 - INOX SS - INOX	F.10 - NERO BLACK - NOIR	Øi	Øe	
TK130T90A	TNY130T90A	130	250	1
TK150T90A	TNY150T90A	150	270	1
TK180T90A	TNY180T90A	180	300	1

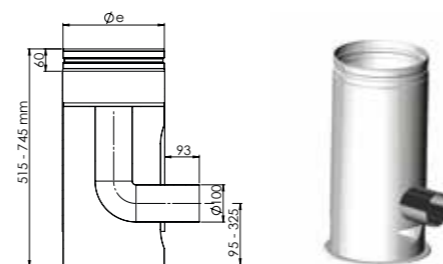

### AIRT

Terminale per tripla parete  
Triple wall cowl - Chapeau pour triple paroi

Finiture disponibili - Available finishes - Finitions disponibles

F.08 - INOX SS - INOX	F.10 - NERO BLACK - NOIR	Øi	Øe	L	
TK080AIRT	TNY080AIRT	80	270	490	1
TK100AIRT	TNY100AIRT	100	270	490	1
TK130AIRT	TNY130AIRT	130	300	490	1
TK150AIRT	TNY150AIRT	150	320	490	1
TK180AIRT	TNY180AIRT	180	350	490	1

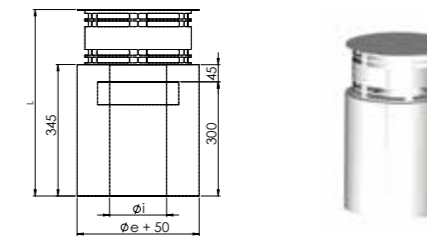

### FM14

Fascetta murale  
Wall clamp - Bride murale

Finiture disponibili - Available finishes - Finitions disponibles

F.08 - INOX SS - INOX	F.10 - NERO BLACK - NOIR	Ø	L	
J200FM14	PJ200FM14	200	180	1
J220FM14	PJ220FM14	220	200	1
J250FM14	PJ250FM14	250	220	1
J270FM14	PJ270FM14	270	250	1
J300FM14	PJ300FM14	300	250	1

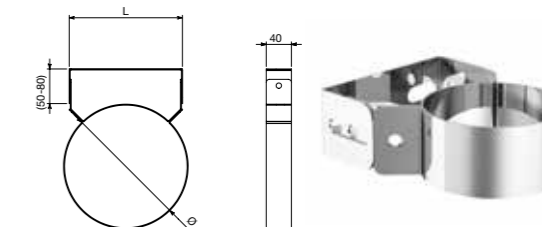

Articolo fornito completo di viteria - Article supplied complete with screws - Article livré complet avec vis

### FB60

Fascetta di bloccaggio  
Locking band - Bride de sécurité

Finiture disponibili - Available finishes - Finitions disponibles

F.08 - INOX SS - INOX	F.10 - NERO BLACK - NOIR	Ø	
TJ200FB60	TNJ200FB60	200	1
TJ220FB60	TNJ220FB60	220	1
TJ250FB60	TNJ250FB60	250	1
TJ270FB60	TNJ270FB60	270	1
TJ300FB60	TNJ300FB60	300	1

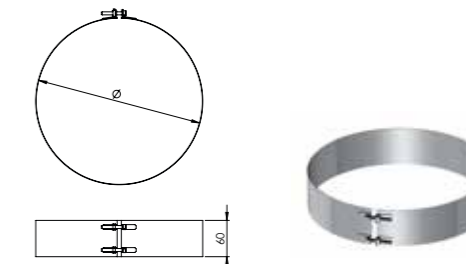

### GUAR

Guarnizione in silicone  
Silicone gasket - Joint silicone

Finiture disponibili - Available finishes - Finitions disponibles

CODICE CODE - CODE	Ø	
TJ200GUAR	200	1
TJ220GUAR	220	1
TJ250GUAR	250	1
TJ270GUAR	270	1

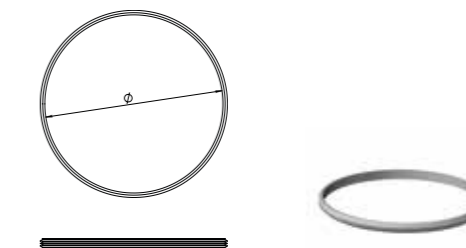



## FP23/24

Faldale per tetti piani

Flashing for flat roofs - Solin pour toits plats

## ALLUMINIO ALUMINIUM ALUMINIUM

F.08 - INOX SS - INOX	F.10 - NERO BLACK - NOIR	Ø	L1	L2	☒
J200FP23	PJ200FP23	200	650	750	1
J220FP23	PJ220FP23	220	650	750	1
J250FP23	PJ250FP23	250	650	750	1
J270FP23	PJ270FP23	270	750	850	1
J300FP23	PJ300FP23	300	750	850	1

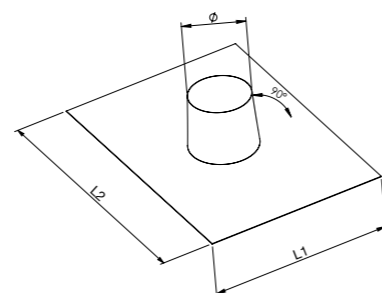

## PIOMBO LEAD PLOMB

F.08 - INOX SS - INOX	F.10 - NERO BLACK - NOIR	Ø	L1	L2	☒
J200FP24	PJ200FP24	200	800	1000	1
J220FP24	PJ220FP24	220	800	1000	1
J250FP24	PJ250FP24	250	800	1000	1
J270FP24	PJ270FP24	270	1000	1000	1
J300FP24	PJ300FP24	300	1000	1000	1

## FI20/21

Faldale per tetti inclinati da 10° a 35°

Flashing for sloped roofs from 10° to 35° - Solin pour toits inclinés de 10° à 35°

## ALLUMINIO ALUMINIUM ALUMINIUM

F.08 - INOX SS - INOX	F.10 - NERO BLACK - NOIR	Ø	L1	L2	☒
J200FI20	PJ200FI20	200	650	750	1
J220FI20	PJ220FI20	220	650	750	1
J250FI20	PJ250FI20	250	650	750	1
J270FI20	PJ270FI20	270	750	850	1
J300FI20	PJ300FI20	300	750	850	1

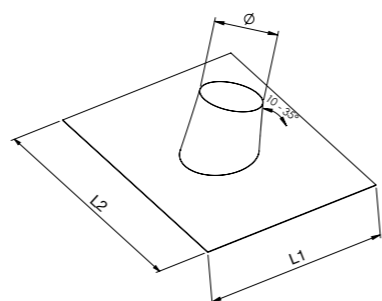

## PIOMBO LEAD PLOMB

F.08 - INOX SS - INOX	F.10 - NERO BLACK - NOIR	Ø	L1	L2	☒
J200FI21	PJ200FI21	200	800	1000	1
J220FI21	PJ220FI21	220	800	1000	1
J250FI21	PJ250FI21	250	800	1000	1
J270FI21	PJ270FI21	270	1000	1000	1
J300FI21	PJ300FI21	300	1000	1000	1

## FI30/31

Faldale con base in gomma per tetti inclinati da 5° a 32°

Flashing with rubber base for sloped roofs from 5° to 32°

Solin avec base en gomme pour toits inclinés de 5° à 32°



## Finiture disponibili - Available finishes - Finitions disponibles

F.08 - INOX SS - INOX	F.10 - NERO BLACK - NOIR	Ø	L1	L2	☒
J200FI30	PJ200FI30	200	625	1006	1
J220FI30	PJ220FI30	220	688	1006	1
J250FI30	PJ250FI30	250	715	1006	1
J270FI30	PJ270FI30	270	715	1006	1
J300FI30	PJ300FI30	300	715	1006	1

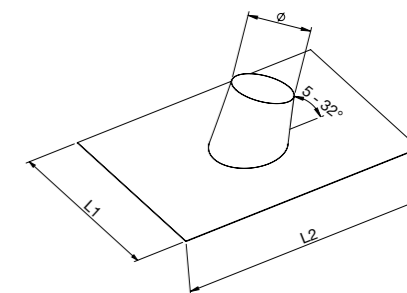
Base in gomma rossa - Base in red rubber  
Base en gomme rouge

## Finiture disponibili - Available finishes - Finitions disponibles

F.08 - INOX SS - INOX	F.10 - NERO BLACK - NOIR	Ø	L1	L2	☒
J200FI31	PJ200FI31	200	625	1006	1
J220FI31	PJ220FI31	220	688	1006	1
J250FI31	PJ250FI31	250	715	1006	1
J270FI31	PJ270FI31	270	715	1006	1
J300FI31	PJ300FI31	300	715	1006	1

Base in gomma nera - Base in black rubber  
Base en gomme noirFaldale in gomma extra-flex con base adesiva, molto malleabile e adattabile ad ogni tipologia di tetto inclinato da 5° a 32°.  
Flashing in extra-flex rubber with adhesive base, which is very malleable and adaptable to any type of sloped roof from 5° to 32°.  
Solin en extra-flex gomme avec base adhésive, qui est très malleable et adaptable à chaque typologie de toit en pente de 5° à 32°.

## FI35/36

Faldale con base in gomma per tetti inclinati da 33° a 45°

Flashing with rubber base for sloped roofs from 33° to 45°

Solin avec base en gomme pour toits inclinés de 33° à 45°

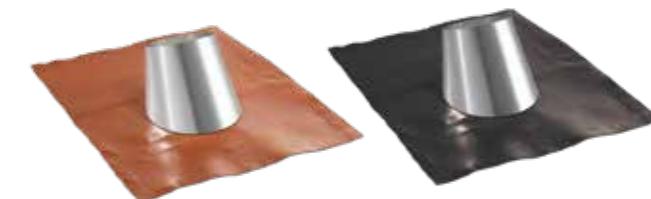

## Finiture disponibili - Available finishes - Finitions disponibles

F.08 - INOX SS - INOX	F.10 - NERO BLACK - NOIR	Ø	L1	L2	☒
J200FI35	PJ200FI35	200	625	1080	1
J220FI35	PJ220FI35	220	685	1080	1
J250FI35	PJ250FI35	250	715	1080	1
J270FI35	PJ270FI35	270	715	1080	1
J300FI35	PJ300FI35	300	715	1080	1

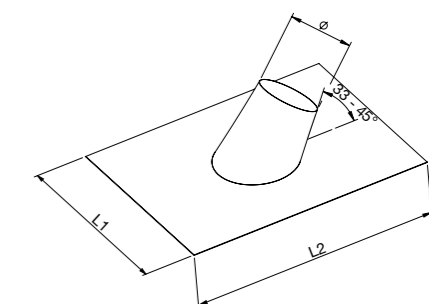
Base in gomma rossa - Base in red rubber  
Base en gomme rouge

## Finiture disponibili - Available finishes - Finitions disponibles

F.08 - INOX SS - INOX	F.10 - NERO BLACK - NOIR	Ø	L1	L2	☒
J200FI36	PJ200FI36	200	625	1080	1
J220FI36	PJ220FI36	220	685	1080	1
J250FI36	PJ250FI36	250	715	1080	1
J270FI36	PJ270FI36	270	715	1080	1
J300FI36	PJ300FI36	300	715	1080	1

Base in gomma nera - Base in black rubber  
Base en gomme noirFaldale in gomma extra-flex con base adesiva, molto malleabile e adattabile ad ogni tipologia di tetto inclinato da 33° a 45°.  
Flashing in extra-flex rubber with adhesive base, which is very malleable and adaptable to any type of sloped roof from 33° to 45°.  
Solin en extra-flex gomme avec base adhésive, qui est très malleable et adaptable à chaque typologie de toit en pente de 33° à 45°.

## SS22

Scossalina

Collar - Colletterte de solin

## Finiture disponibili - Available finishes - Finitions disponibles

F.08 - INOX SS - INOX	F.10 - NERO BLACK - NOIR	Ø1	Ø2	☒
J200SS22	PJ200SS22	200	300	1
J220SS22	PJ220SS22	220	320	1
J250SS22	PJ250SS22	250	350	1
J270SS22	PJ270SS22	270	400	1
J300SS22	PJ300SS22	300	400	1

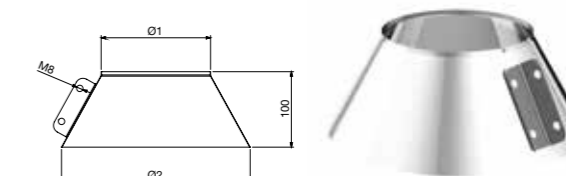

## FIN1

Piastra quadrata di finitura da 0° a 30°

Square finishing plate from 0° to 30° - Plaque carrée de finition de 0° à 30°

Finiture disponibili - Available finishes - Finitions disponibles

F.08 - INOX SS - INOX	F.10 - NERO BLACK - NOIR	Ø	L1	L2	📦
J200FIN1	PJ200FIN1	200	460	430	1
J220FIN1	PJ220FIN1	220	500	430	1
J250FIN1	PJ250FIN1	250	525	430	1
J270FIN1	PJ270FIN1	270	570	460	1
J300FIN1	PJ300FIN1	300	570	460	1

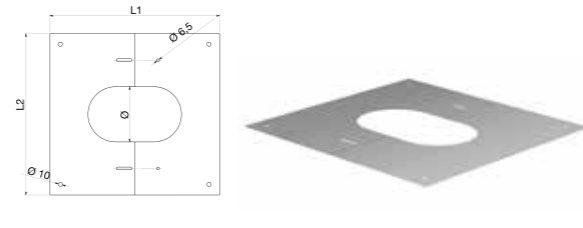

Articolo fornito completo di viteria - Article supplied complete with screws - Article livré complet avec vis

## FIN2

Piastra quadrata di finitura da 30° a 45°

Square finishing plate from 30° to 45° - Plaque carrée de finition de 30° à 45°

Finiture disponibili - Available finishes - Finitions disponibles

F.08 - INOX SS - INOX	F.10 - NERO BLACK - NOIR	Ø	L1	L2	📦
J200FIN2	PJ200FIN2	200	530	430	1
J220FIN2	PJ220FIN2	220	580	430	1
J250FIN2	PJ250FIN2	250	620	440	1
J270FIN2	PJ270FIN2	270	890	560	1
J300FIN2	PJ300FIN2	300	890	560	1

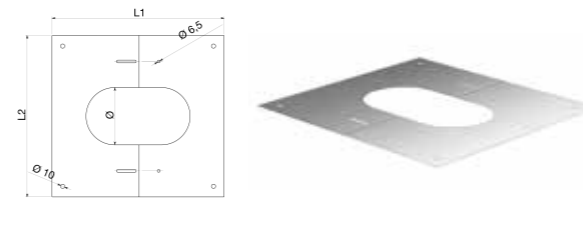

Articolo fornito completo di viteria - Article supplied complete with screws - Article livré complet avec vis

## FIN3

Piastra tonda di finitura

Round finishing plate - Plaque ronde de finition

Finiture disponibili - Available finishes - Finitions disponibles

F.08 - INOX SS - INOX	F.10 - NERO BLACK - NOIR	Ø1	Ø2	📦
J200FIN3	PJ200FIN3	200	450	1
J220FIN3	PJ220FIN3	220	450	1
J250FIN3	PJ250FIN3	250	450	1
J270FIN3	PJ270FIN3	270	500	1
J300FIN3	PJ300FIN3	300	500	1

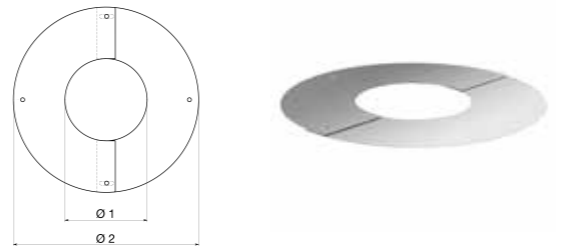

Articolo fornito completo di viteria - Article supplied complete with screws - Article livré complet avec vis

## COPA

Coppella con rivestimento in alluminio resistente fino a 600°C

Thermal insulation with aluminium coating resistant up to 600°C

Isolation thermique avec revêtement en aluminium résistant jusqu'à 600°C

Finiture disponibili - Available finishes - Finitions disponibles

CODICE CODE - CODE	Ø	SP	h	📦
TK200COPA	200	50	850	1
TK220COPA	220	50	850	1
TK250COPA	250	50	850	1
TK270COPA	270	50	850	1
TK300COPA	300	50	850	1

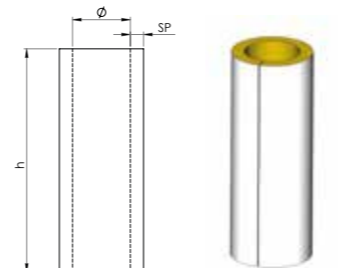

## FORXS - FORX2

FORXS e FORX2 sono delle fascette complete di ali di fissaggio e supporto, regolabili in inclinazione da 0° a 45°.

Queste fascette vincolano la canna fumaria che attraversa il solaio in condizione verticale.

Sono leggere ma allo stesso tempo robuste grazie alla solidità della piegatura presente sulle ali.

Sono poco ingombranti, adatte ad essere installate su tetti e solai.

FORXS and FORX2 are clamps with fixing and support wings, adjustable in inclination from 0° to 45°.

These clamps bind the chimney that crosses the roof in a vertical condition.

They are light but at the same time robust thanks to the solidity of the wings bending.

They are not very bulky, and they are apt to be installed on roofs and floors.

FORXS et FORX2 sont des brides avec des ailes de fixation et support, ajustables en inclination de 0° à 45°.

Ces brides immobilisent la cheminée qui traverse le plancher en condition verticale.

Elles sont légères mais au même temps robustes grâce à la solidité du pliage présent sur les ailes.

Elles ne sont pas très encombrantes, aptes pour être installées sur les toits et les planchers.

## FORXS

Fascetta con ali per supporto a tetto

Roof support with wings - Support au toit avec ailes

Finiture disponibili - Available finishes - Finitions disponibles

F.08 - INOX SS - INOX	F.10 - NERO BLACK - NOIR	Ø	📦
J200FORXS	-	200	1
J220FORXS	-	220	1
J250FORXS	-	250	1
J270FORXS	-	270	1
J300FORXS	-	300	1

Articolo fornito completo di viteria - Article supplied complete with screws - Article livré complet avec vis

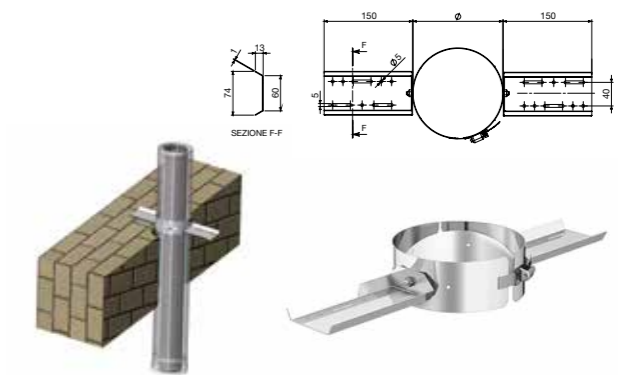

## FORX2

Fascetta con staffe L1000 mm per supporto a tetto

Clamp with bars L1000 mm for roof support

Bride avec traversés L1000 mm pour support au toit

Finiture disponibili - Available finishes - Finitions disponibles

F.08 - INOX SS - INOX	F.10 - NERO BLACK - NOIR	Ø	📦
Z200FORX2	-	200	1
Z220FORX2	-	220	1
Z250FORX2	-	250	1
Z270FORX2	-	270	1
Z300FORX2	-	300	1

Articolo fornito completo di viteria - Article supplied complete with screws - Article livré complet avec vis

